

SPINAS15 - PCB

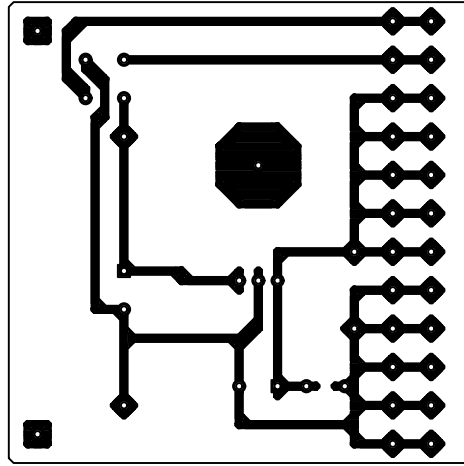

LAYOUT BOTTOM-SIDE

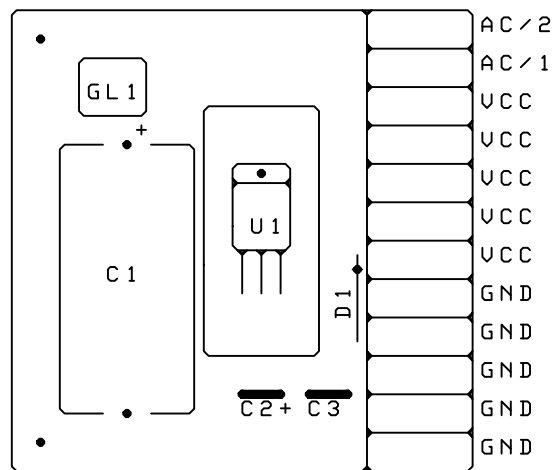

PLACEMENT